

Linear

LINI Blade-H R007 (DIR) Fixture Guide

KKDÖ

Indoor | Suspended | Output up to 1575lm/m (480lm/ft)



Key applications

- ✓ Ceiling pendant
- ✓ Interior
- ✓ Direct/indirect lighting
- ✓ Uplighting

Key features

- ✓ Custom lengths
- ✓ Direct view
- ✓ Constant Voltage (CV)
- ✓ Extensive CCT range
- ✓ Decorative
- ✓ IP20 dry area
- ✓ Diffusion: homogenous
- ✓ Lens options

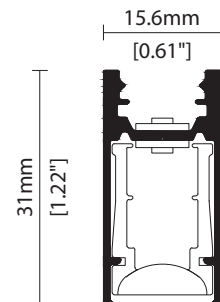

MOUNTING METHODS



KKS-06 Suspension mounting kit

Linear

LINE Blade-H R007 (DIR)

Specification sheet



Dimensions	H31/W15.6/L270-2020mm (H1.22/W0.61/L10.62-79.53in)
PCB Cut-point	41.7mm increment/2000mm max (1.64in increment/78.74in max)
LED Pitch	6.95mm-144LED/m (0.27in - 44LED/ft)
Chip	s-line k-line
Cover/Optics	DIR: Diffused (110°)/KKLN-01 Lens (14°)/IND: No cover (105°)
CCT	s-line: 1900K/2100K/2300K/2500K/2700K/3000K/3500K/4000K/5000K k-line: 1900K/2100K/2300K/2500K/2700K/3000K/3500K/4000K/5000K
LED binning	s-line: 2-step MacAdam ellipse k-line: 3-step MacAdam ellipse
CRI	≥92
Lifetime	50,000 hours @ 25°C (50,000 hours @ 77°F)
Operating temp	T _a = -25 to 50°C (T _c max = 73°C) T _a = -13 to 122°F (T _c max = 163°F)
IP Rating	IP20
Finish	Matt White/Matt Black/Matt Gray/Matt Silver/Bronze Powder coating
Mounting	Suspended via suspension kit
Power feed	Hardwire tails
Control	0-10V/1-10V/DMX/DALI

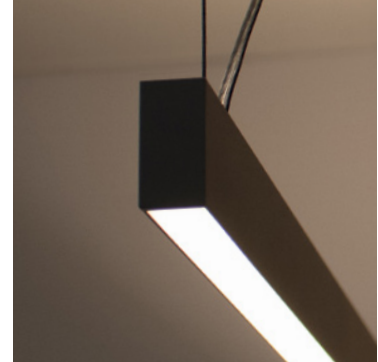

LED Grading Key

Exclusive Grade

s-line* 2-step CCT range *KKDC tuned CCT range

Base Grade

k-line 3-step commercial range Energy Star CCTs

Power consumption	Supply voltage	Supply current
24.5W/m (7.47W/ft)	24V DC	1.02A/m (0.31A/ft)

Performance Data (3000K)

	R1	R2	R3	R4	R5	R6	R7	R8	R9	R10	R11	R12	R13	R14
k-line	93	97	98	91	92	95	92	84	65	92	91	74	95	99

	R007 + 14° KKLN-01 (DIR)	R007 + Diffused (DIR)	R007 + No Cover(IND)	R014 + No Cover(IND)	R020 + No Cover(IND)	CRI	R9	Rf	Rg
s-line	319lm/m (97lm/ft) 45.6lm/W	148lm/m (45lm/ft) 21.2lm/W	434lm/m (132lm/ft) 82.7lm/W	879lm/m (268lm/ft) 83.7lm/W	1256lm/m (383lm/ft) 83.7lm/W	93	66	-	-
k-line	301lm/m (92lm/ft) 43lm/W	140lm/m (43lm/ft) 20lm/W	410lm/m (125lm/ft) 78lm/W	830lm/m (253lm/ft) 79lm/W	1185lm/m (361lm/ft) 79lm/W	92	65	-	-

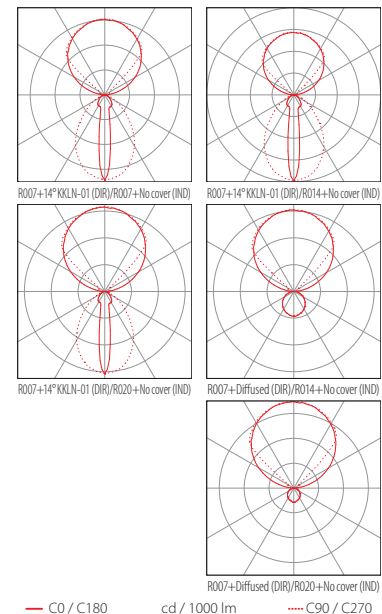
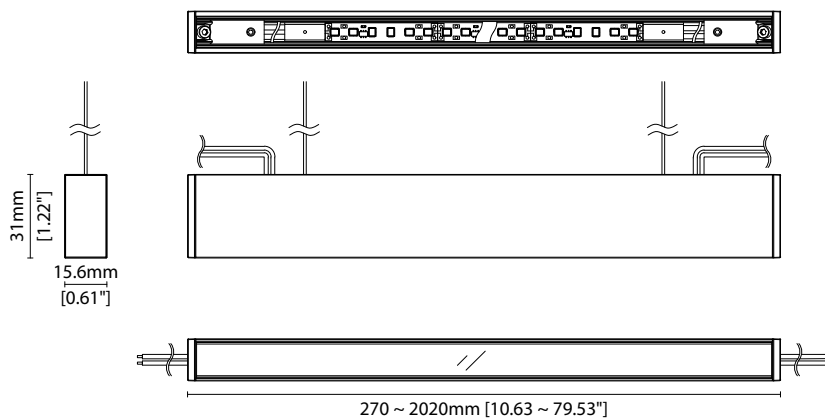

Data derived from independent UKAS / IESNA LM-79-08 accredited testing of production samples.

LINI Blade-H R007 (DIR)

Code Table



FIXTURE

Model	Finish	Cover/Lens ¹	Grade ²	LED	Colour (CCT)	Length Availability ³	IP	Cable Length	Power Feed	Input								
LINI Blade-H	BH	Matt White Paint	MW	14° (DIR) No cover (IND)	S	s	R007 (DIR) + R007 (IND)	R0707	1900K 19 2100K 21	m	270-2020mm 41.7mm increments	IP20 20	3000mm/ 118.11"	3000	Suspension single no sheath tail ⁴	S00H	DC 24V	g
		Matt Silver Paint	MS			k	R007 (DIR) + R014 (IND)	R0714	2300K 23 2500K 25	i	10.62-79.53in 1.64in increments							
		Matt Grey Paint	MG	Diffused (DIR) No cover (IND)	C			R007 (DIR) + R020 (IND)	R0720	2700K 27 3000K 30 3500K 35 4000K 40 5000K 50		(Specify length code OR total run length)						
		Matt Black Paint	MB															
		Bronze Paint	BP															

¹ Refer to **Cover/Lens Options** on **Options** pages

² Refer to **LED Grading Key** on **Specification sheet** page

³ Refer to **Length Availability List** or enter total run length instead of length code

⁴ Transparent suspension wire

Code Example:

BH	-	MW	-	C	-	s	-	R0707	-	35	-	m	520	-	20	-	0300	-	S00H	-	g
LINI Blade-H		Matt White Paint		Diffused (DIR) No cover (IND)				R007 (DIR) + R007 (IND)		3500K		m	520mm		IP20		300mm/11.81"		Suspension single no sheath tail		DC 24V

ACCESSORIES

Mounting Accessories

KKSW-06 Suspension Mounting Kit

* Refer to **Mounting accessories** on **Accessories** pages

Connection Accessories

KKCN-01 2 PIN male & female 50mm (1.97in) pair

KKCN-03 2 PIN male & female 300mm (11.81in) pair

KKCN-06 2 PIN 300mm (11.81in) extension lead

* Refer to **Power feed** on **Accessories** pages

PSU/Driver

0-10V/1-10V/DALI/DMX

* Refer to **Driver/PSU Options** page for details or provide requirement and KKDC to offer the suitable option

LED ENGINE VARIANTS (LED STRIP TYPE)

Colour	LED	Lumen/m	Lumen/ft	W/m	W/ft	Spec Doc	Length	Increment
Single CCT	R0707	1256	383	22	6.71	LINI Blade-H R007	270-2020mm (10.62-79.53in)	41.7mm (1.64in)
	R0714	879	268	24.5	7.47	LINI Blade-H R014	270-2020mm (10.62-79.53in)	41.7mm (1.64in)
	R0720	933	284	25.3	7.70	LINI Blade-H R020	270-2020mm (10.62-79.53in)	41.7mm (1.64in)

* Performance data: (DIR), s-line, KKLN-01 lens, 3000K

LINI Blade-H R007 (DIR)

Length Availability List



LINI BLADE-H R007 (DIR) + R007(IND) / R014(IND) / R020(IND)

Length Code		Fixture Length ¹		(DIR) LED Strip ²		(IND) LED Strip ²		End Cap Dimension ³	
Metric	Imperial(US)	Metric	Imperial(US)	Metric	Imperial(US)	Metric	Imperial(US)	Metric	Imperial(US)
m0270	i0011	270mm	10.63in	250mm	9.84in	125mm	4.92in	5mm	0.20in
m0312	i0012	312mm	12.27in	292mm	11.48in	167mm	6.56in	5mm	0.20in
m0353	i0014	353mm	13.91in	333mm	13.12in	208mm	8.20in	5mm	0.20in
m0395	i0016	395mm	15.55in	375mm	14.76in	250mm	9.84in	5mm	0.20in
m0437	i0017	437mm	17.19in	417mm	16.40in	292mm	11.48in	5mm	0.20in
m0478	i0019	478mm	18.83in	458mm	18.04in	333mm	13.12in	5mm	0.20in
m0520	i0020	520mm	20.47in	500mm	19.69in	375mm	14.76in	5mm	0.20in
m0562	i0022	562mm	22.11in	542mm	21.33in	417mm	16.40in	5mm	0.20in
m0603	i0024	603mm	23.75in	583mm	22.97in	458mm	18.04in	5mm	0.20in
m0645	i0025	645mm	25.39in	625mm	24.61in	500mm	19.69in	5mm	0.20in
m0687	i0027	687mm	27.03in	667mm	26.25in	542mm	21.33in	5mm	0.20in
m0728	i0029	728mm	28.67in	708mm	27.89in	583mm	22.97in	5mm	0.20in
m0770	i0030	770mm	30.31in	750mm	29.53in	625mm	24.61in	5mm	0.20in
m0812	i0032	812mm	31.96in	792mm	31.17in	667mm	26.25in	5mm	0.20in
m0853	i0034	853mm	33.60in	833mm	32.81in	708mm	27.89in	5mm	0.20in
m0895	i0035	895mm	35.24in	875mm	34.45in	750mm	29.53in	5mm	0.20in
m0937	i0037	937mm	36.88in	917mm	36.09in	792mm	31.17in	5mm	0.20in
m0978	i0039	978mm	38.52in	958mm	37.73in	833mm	32.81in	5mm	0.20in
m1020	i0040	1020mm	40.16in	1000mm	39.37in	875mm	34.45in	5mm	0.20in
m1062	i0042	1062mm	41.80in	1042mm	41.01in	917mm	36.09in	5mm	0.20in
m1103	i0043	1103mm	43.44in	1083mm	42.65in	958mm	37.73in	5mm	0.20in
m1145	i0045	1145mm	45.08in	1125mm	44.29in	1000mm	39.37in	5mm	0.20in
m1187	i0047	1187mm	46.72in	1167mm	45.93in	1042mm	41.01in	5mm	0.20in
m1228	i0048	1228mm	48.36in	1208mm	47.57in	1083mm	42.65in	5mm	0.20in
m1270	i0050	1270mm	50.00in	1250mm	49.21in	1125mm	44.29in	5mm	0.20in
m1312	i0052	1312mm	51.64in	1292mm	50.85in	1167mm	45.93in	5mm	0.20in
m1353	i0053	1353mm	53.28in	1333mm	52.49in	1208mm	47.57in	5mm	0.20in
m1395	i0055	1395mm	54.92in	1375mm	54.13in	1250mm	49.21in	5mm	0.20in
m1437	i0057	1437mm	56.56in	1417mm	55.77in	1292mm	50.85in	5mm	0.20in
m1478	i0058	1478mm	58.20in	1458mm	57.41in	1333mm	52.49in	5mm	0.20in
m1520	i0060	1520mm	59.84in	1500mm	59.06in	1375mm	54.13in	5mm	0.20in
m1562	i0061	1562mm	61.48in	1542mm	60.70in	1417mm	55.77in	5mm	0.20in
m1603	i0063	1603mm	63.12in	1583mm	62.34in	1458mm	57.41in	5mm	0.20in
m1645	i0065	1645mm	64.76in	1625mm	63.98in	1500mm	59.06in	5mm	0.20in
m1687	i0066	1687mm	66.40in	1667mm	65.62in	1542mm	60.70in	5mm	0.20in
m1728	i0068	1728mm	68.04in	1708mm	67.26in	1583mm	62.34in	5mm	0.20in
m1770	i0070	1770mm	69.69in	1750mm	68.90in	1625mm	63.98in	5mm	0.20in
m1812	i0071	1812mm	71.33in	1792mm	70.54in	1667mm	65.62in	5mm	0.20in

LINE Blade-H R007 (DIR)

Length Availability List



Length Code		Fixture Length ¹		(DIR) LED Strip ²		(IND) LED Strip ²		End Cap Dimension ³	
Metric	Imperial(US)	Metric	Imperial(US)	Metric	Imperial(US)	Metric	Imperial(US)	Metric	Imperial(US)
m1853	i0073	1853mm	72.97in	1833mm	72.18in	1708mm	67.26in	5mm	0.20in
m1895	i0075	1895mm	74.61in	1875mm	73.82in	1750mm	68.90in	5mm	0.20in
m1937	i0076	1937mm	76.25in	1917mm	75.46in	1792mm	70.54in	5mm	0.20in
m1978	i0078	1978mm	77.89in	1958mm	77.10in	1833mm	72.18in	5mm	0.20in
m2020	i0080	2020mm	79.53in	2000mm	78.74in	1875mm	73.82in	5mm	0.20in

¹ Actual total overall length of light fixture (LED strip + end caps + void/wire hole)

² Actual length of PCB strip

³ Actual length of 2x end caps

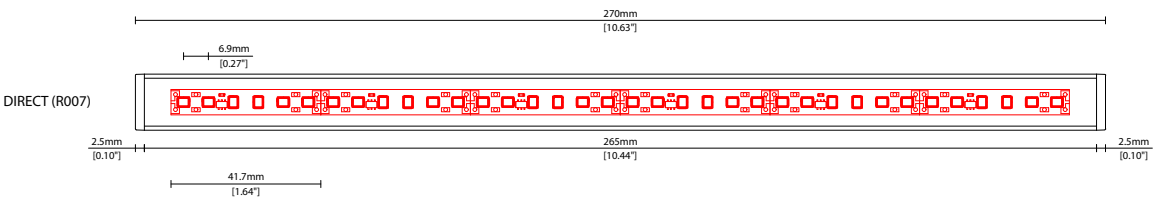
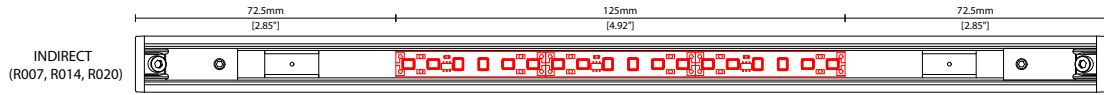

Linear

LINI Blade-H R007 (DIR) Options

KKDC

COVER/LENS OPTIONS

* Options are an integral part of the fixture ordering codes. Please refer to **Code Table** pages.



C Diffused (DIR)

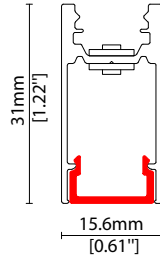

S 14° KKLN-01 (DIR)

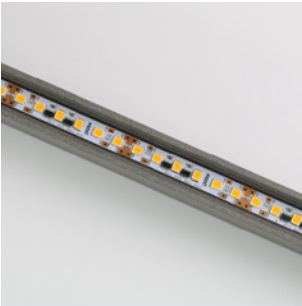
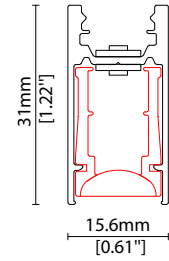

No cover (IND)

Linear

LINI Blade-H R007 (DIR) Options

KKDC

POWER FEED OPTIONS

* Options are an integral part of the fixture ordering codes. Please refer to **Code Table** pages.

3000 S00H 3000mm (118.11") Suspension single no sheath tail

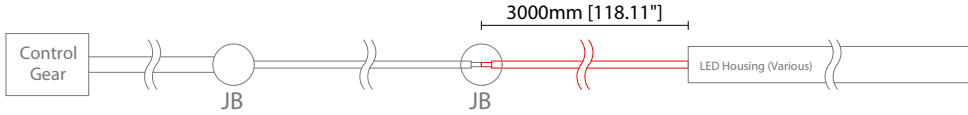

Key

Control Gear Power supply, sub-controllers & control systems
JB Junction box / cable connection

MOUNTING ACCESSORIES

Note: Accessories are to be ordered separately with corresponding code shown below.



KKSW-06

Suspension mounting kit
(allow 2 per metre/40in)
S/Steel finish
L14.9/W16/H3031mm MAX
(L0.59/W0.63/H119.33" MAX)

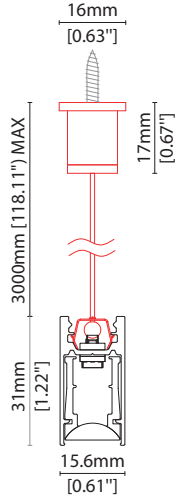

POWER FEED

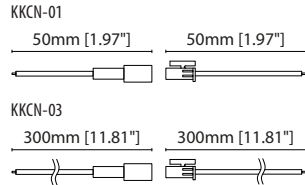
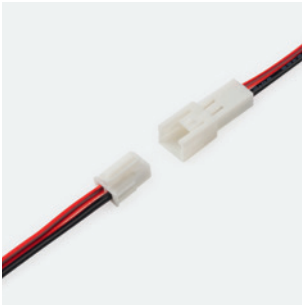

KKCN-01 50mm (1.97in) pair
KKCN-03 300mm (11.81in) pair
2 PIN male + female connector set

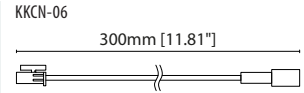

KKCN-06
2 PIN 300mm (11.81in) extension lead

KKDC CONTROL



IP20
Plastic housing
L170/W59/H29mm
(L6.69/W2.32/H1.14in)

KKDM-06 1-10V
visDIM dimmable sub-controller
(4 x 8A max @ 12-36V)



IP20
Plastic housing
L170/W53.4/H28mm
(L6.69/W2.10/H1.10in)

KKSC-05 DMX
visDIM dimmable sub-controller
(4 x 5A max @ 12-36V)

Linear

LINI Blade-H R007 (DIR) Accessories

KKDC

KKDC CONTROL (CONTINUED)



IP20
Plastic housing
L170/W59/H29mm
(L6.69/W2.32/H1.14in)

KKDL-02 DALI

visDIM dimmable sub-controller
(4 x 8A max @ 12-36V)



IP20
Plastic housing
L166/W53.4/H23mm
(L6.54/W2.10/H0.91in)

KKDL-03 DALI

visDIM dimmable sub-controller
(4 x 5A max @ 12-36V)

AVAILABLE PSU OPTIONS

Control Mode	PSU (Order Code)	Input Voltage AC	Output Voltage DC	Rated Output Current	Rated Power	Dim %	IP Rating
Switched	CEN-60-24	90-295V	24V	2.5A	60W	-	IP67
	HLG-60H-24	90-305V	24V	2.5A	60W	-	IP67
	HLG-100H-24	90-305V	24V	4.0A	100W	-	IP67
	HLG-150H-24	90-305V	24V	6.3A	150W	-	IP67
	HLG-240H-24	90-305V	24V	10A	240W	-	IP67
0-10V (1-10V)	PWM-40-24	90-305V	24V	1.67A	40W	100-0.15 (100-10)	IP67
	PWM-60-24	90-305V	24V	2.5A	60W	100-0.15 (100-10)	IP67
	PWM-90-24	90-305V	24V	3.67A	90W	100-0.15 (100-10)	IP67
	PWM-120-24	90-305V	24V	5.0A	120W	100-0.15 (100-10)	IP67
DALI	LIN100A1	120-277V	24V	1A per channel	100W	100-0.1	IP66/IP40
DMX RGB	LIN100A1	120-277V	24V	1.33A per channel	100W	100-0.1	IP66/IP40
DMX RGBW	LIN100A1	120-277A	24V	1A per channel	100W	100-0.1	IP66/IP40

Flicker Free Options - Combination of PSU+ sub-controller

Control Mode	PSU (Order Code)	Sub-controller (Order Code)	Input Voltage AC	Output Voltage DC	Rated Output Current	Rated Power	Dim %	IP Rating PSU/ Sub-controller
0-10V or 1-10V	CEN-60-24	KKDM-06	90-295V	24V	2.5A	60W	100-0.9	IP67/IP20
	HLG-60H-24	KKDM-06	90-295V	24V	2.5A	60W	100-0.9	IP67/IP20
	HLG-100H-24	KKDM-06	90-295V	24V	4.0A	100W	100-0.9	IP67/IP20
	HLG-150H-24	KKDM-06	90-295V	24V	6.3A	150W	100-0.9	IP67/IP20
	HLG-240H-24	KKDM-06	90-295V	24V	10.0A	240W	100-0.9	IP67/IP20
	CEN-60-24	KKDL-02/03	90-295V	24V	2.5A	60W	100-0.1	IP67/IP20
DALI	HLG-60H-24	KKDL-02/03	90-305V	24V	2.5A	60W	100-0.1	IP67/IP20
	HLG-100H-24	KKDL-02/03	90-305V	24V	4.0A	100W	100-0.1	IP67/IP20
	HLG-150H-24	KKDL-02/03	90-305V	24V	6.3A	150W	100-0.1	IP67/IP20
	HLG-240H-24	KKDL-02/03	90-305V	24V	10.0A	240W	100-0.1	IP67/IP20
DMX RGB	CEN-60-24	KKSC-05	90-295V	24V	2.5A	60W	100-0.9	IP67/IP20
	HLG-60H-24	KKSC-05	90-305V	24V	2.5A	60W	100-0.9	IP67/IP20
	HLG-100H-24	KKSC-05	90-305V	24V	4A	100W	100-0.9	IP67/IP20
	HLG-150H-24	KKSC-05	90-305V	24V	6.3A	150W	100-0.9	IP67/IP20
	HLG-240H-24	KKSC-05	90-305V	24V	10.0A	240W	100-0.9	IP67/IP20

¹ The items shown above cover the most frequently used specification but does not exhaust the possible options

² PSU and/or driver can be chosen from the table, or KKDC may recommend the best option upon receipt of the controls requirement and installation environment

³ Electrical shop drawing will include detailed information of PSU and relevant control drivers

⁴ Cut sheets are available on the controls section of www.kkdc.lighting or upon request